

# **CRYSTAL FIRES**

**(miami) Cf1 and MANHATTAN**

**Inset Conventional  
Flue Fire**

**USER INSTALLATION AND  
SERVICING INSTRUCTIONS**

FOR USE WITH NATURAL GAS  
G20 @ 20 mbar  
For use in GB and IE

**CE**

**THESE INSTRUCTIONS MUST BE LEFT  
WITH THE USER FOR FUTURE REFERENCE**

Users instructions	
Section No	page No

1) important notes	3
2) How to light and operate standard semi remote control system	4
3) Cleaning and simple maintenance	7
4) Spares and service	7
5) User replaceable parts	7

Installation instructions	
Section No	page No

6) parts supplied/box contents	8
7) Installation requirements	8
8) Technical data	9
9) Dimensions	10
10) Contents of fixing kit	10
11)Appliance location	11
12)Flue requirements and builders opening requirements	12
13)Surround requirements	13
14)Ventilation	14
15)Gas requirements	14
16)Installation of fire	14
17)Commissioning the fire	16
18)Fuel effect - logs and driftwood layouts	17
19)Fuel effect - pebbles layout	20
20)Lighting the fire	22
21)Checking for spillage	22
22)Instruct the user	22
23)Service and maintenance	23
24)Spare parts	26

**These instructions cover 2 appliances the cf1 (miami )and manhattan  
The only difference being the manhattan is 150 mm taller**

**Thank you for purchasing a crystal gas fire you are now a proud owner of a crystal cf1(miami) /manhattan which if serviced annually will provide years of trouble free service**

# CRYSTAL CF1/MANHATTAN

## USERS INSTRUCTIONS

### 1.IMPORTANT NOTES

#### 1:1

This fire should be installed and serviced every 12 months in accordance with current gas safety (installation and uses) regulations by a competent person who is a member of a recognised gas installer's organisation (e.g. Gas safe ) and in accordance with the installation instructions.

#### 1:2

The flue should be inspected before your appliance is installed and checked annually to ensure continuous clearance of combustion products and safe operation.

Where solid fuel has been used the chimney must be swept before installation.

#### 1:3

**UNDER NO CIRCUMSTANCES** must the fire be used if the glass door panel is broken cracked or damaged

#### 1:4

#### **IMPORTANT.**

The glass panel door and other outer parts, (e.g. outer frame and door) will become hot in use; clothes etc., should not be wrapped over or near the fire and we recommend that a 'fire guard conforming to BS 8423 should be used for the protection of young children the elderly the infirm and pets'.

#### 1:5

**DO NOT** burn paper or rubbish in the fire.

#### 1:6

It is important for the safe operation and to maintain efficiency that the fire is not operated with damaged or broken fuel effect pieces or ceramics.

**UNDER NO CIRCUMSTANCES** should extra fuel effect pieces be used.

#### 1:7

When the fire is first used it may emit a slight odour or smoke, this is due to the newness and will disappear. **DO NOT WASH OR VACUUM** the Fuel Effect ceramic pieces.

#### 1:8

The fire **MUST** be installed into a Builders Opening in line with the Installation Instructions.

No combustible material should be placed within 150mm of the appliance

Any combustible material above the opening should be removed up to a height of 500mm. any shelf above the fire should not project more than 150mm forward.

For deeper shelves allow a 15mm increase in height for every 25mm in depth.

#### 1:9

These instructions are intended to assist you in the correct operation of your appliance and

Should be kept safe for future reference

## 2. How to light and operate

**SAFETY:** - The fire is fitted with a flame supervision and atmosphere sensing device (Oxy pilot) that will shut off the gas supply if the pilot light should go out for any reason. It will extinguish the pilot light if the oxygen content in the room falls below a prescribed level.

If the pilot light keeps going out seek expert help.

**2:0**

**WARNING:** - If the fire is extinguished and the control is **not** in the **off position**, the control should be returned to the off position and no attempt should be made to relight the fire until 3 minutes have elapsed. If the pilot cannot be relit seek expert help.

The batteries required to operate the control system should have been fitted by the installer

The Installer may have left the fire at the pilot setting and it is important that you read the

Section headed 'Lighting the Pilot' if you decide to turn off the pilot and prefer to relight it each time you use the fire.

**2:1**

### Lighting the Pilot.

You will find this operation quite simple if you refer to Fig 2:1 showing the Buttons on the Remote Control Handset and read this section Before Lighting the Fire.

Open the outer door of the fire and the **control** can be seen at the base of the fire.

Making reference to figure 2:1a familiarise yourself with the knobs.

First check that **Control knob 'B'** is set at the maximum setting.

Secondly check that **Control knob 'A'** is set at the off position as shown in the picture.

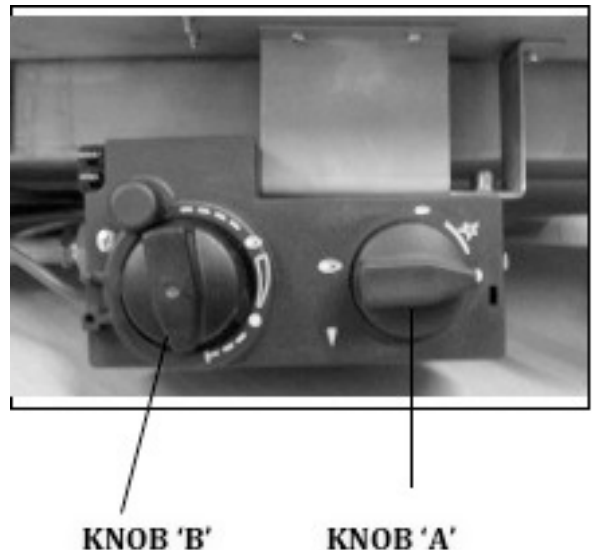

**Fig 2:1a**

It will be necessary to see the pilot and it is visible at the front left centre of the fuel bed, see **Fig 2:1b**.

To light the pilot turn **Knob 'A'** to the **Pilot Ignition Star Setting** and keep the knob pushed in for **5 seconds** before turning the knob further to operate the **Piezo Igniter**.

You will hear a click and see a spark at the pilot and the pilot should light.

If it does not light turn the knob back to off setting and repeat the operation. (This may take several attempts on the first lighting).

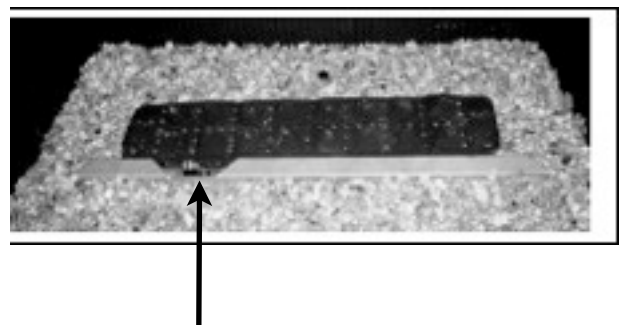

**Pilot position shown above at cut out on left side Fig 2:1b**

Once the pilot has lit **do not** release the knob, keep it held in for a further 15seconds.

You can then release the knob and the pilot flame should stay alight.

If it goes out turn the knob back to the off setting and repeat the operation but once the pilot flame is lit hold the knob in a little longer before releasing it.

Now turn the **Knob 'A'** as far as it will turn to the maximum flame setting.

The main burner will now light at the maximum setting.

The fire is now lit so you can close the outer door and operate the fire using the **remote control handset**.

And read the section headed '**Choosing your heat setting**'.

You do not need to light the pilot every time you light the fire. You can leave the pilot lit all the time if the property is occupied. This way the fire can be totally operated by the remote control handset.

If the fire cannot be lit then seek expert help.

*Keeping the pilot lit keeps the chimney warm and helps reduce condensation marks on the door glass panel.*

## **2:2**

### **Turning the Pilot Off.**

If you decide to turn the pilot off wait until the fire is cool and open the outer door.

Now simply turn **Knob 'A'** to the off setting.

You will not be able to relight the fire or turn the knob for at least 10seconds as the control has a built in safety lock.

Do not force the knob, as this will damage the control. Wait until the safety lock is released.

## **2:3**

### **Choosing your heat setting.**

There are 2 arrows on the remote control handset, with the fire at the maximum setting point the remote control at the fire and press the bottom arrow to reduce the heat setting the flame heights will lower.

**(It is necessary to press the top button and the small button on the left together to increase the heat setting, this is a safety feature)**

Over time you will find the ideal heat setting for your room. The handset can be used to vary the heat setting up or down or turn the main burner off completely so that only the pilot is alight.

When you press the handset you may hear the small motor at the control, which is turning **Knob 'B'** electronically, this is quite normal.

## **2:4**

### **Operating the Control System Without Batteries**

The Control System can be operated without batteries.

Light the pilot as detailed above in **Section 2:1a Lighting the Pilot.**

With the Outer door open turn **Knob 'B'** to the desired setting, you will notice some resistance when you turn the knob as it will click as it is turned, this is quite normal but do not force the knob.

It is recommended that new batteries be fitted as soon as possible.

## 2:5

### **Replacing the Batteries in the Remote Control Handset.**

Remove the cover from the back of the Remote Control Handset.  
Carefully remove the battery with clip from the Handset.  
Remove the clip from the top of the battery and exchange for a new battery (Type 6LR61).

It is recommended that Alkaline Long Life Batteries are used.  
Refit the battery back into the handset and refit the cover.

We recommend that the batteries in the Handset and Receiver be exchanged annually.



**Fig 2:5a**

## 2:6

### **Replacing the Batteries in the Receiver**

Open the fire outer door and making reference to **Fig 2:6** you will see a small black Plastic box, this is the Receiver. You will notice it as a small red light that should be facing you. Carefully slide the cover off the top of the box and fit/replace the 4 Type 'AA' batteries making sure they are fitted the correct way around. Replace the cover and place the receiver back in position ensuring the Red Light is facing you.

It is recommended that Alkaline Long Life Batteries be used.  
Over time the red light will reduce in brightness indicating that the batteries require changing.  
We recommend that the batteries in the Handset and Receiver is exchanged annually.



**Fig 2:6**

**Fig 2:1**  
Handset right



## 4:1

For spares and service, contact your local supplier or installer stating the appliance NAME, MODEL, SERIAL NUMBER

### 3.cleaning and simple maintenance

#### 3:1

All cleaning should be carried out when the fire is cold. The fire will retain heat for some time after it has been switched off.

#### 3:2

If any of the Fuel Effect Logs Driftwood or Pebble Pieces is seen to be broken or damaged replacements must be obtained from your Installer.

If soot is seen to be building up on the Fuel Effect Logs Driftwood or Pebble Pieces it is indicating that the Fire requires Servicing.

#### 3.5

Due to the nature of the convection air flowing over the fire the walls of the room directly around and above the fire may become discoloured. This is due to particles of dust being carried by the convection air through the fire and up and around the walls.

Certain wall coverings like blown vinyl should not be used on the wall around the fire.

#### 3.6

**Again ensure the fire and glass panel are cold before proceeding.**

**Like all glass windows the glass will become dirty and require cleaning.**

The glass door can be cleaned on both the **outside** and **inside** with a damp cloth, allowed to dry then wiped with a dry cloth to remove smears. To do this open the **Outer Door**

remove the 2 screws at the Left Hand side, the **Glass Door** will then open.

**Important.**

**After cleaning it is important that the Glass Door is sealed closed with the 2 fixing screws.**

**If the Glass Door Panel is found to be Cracked, Chipped or Damaged the Fire Must Not Be used until it has been changed.**

**Important.**

**Do not disturb the Fuel Effect Logs Driftwood or Pebble Pieces.**

### 4.spares and service

#### 4:2

Regular service and inspection should be undertaken to ensure continued safe operation.

It is recommended that your fire and flue should be checked and serviced annually by a competent person for continued safe operation

### 5.user replaceable parts

PART NO.	DESCRIPTION
0001	REMOTE CONTROL HANDSET
0002	Driftwood set
0003	LOGSET
0004	PEBBLE SET

**Installation instructions**  
Cf1(miami) and manhattan

6.parts supplied box contents

**The Fire is supplied in 2 Boxes.cf1 (miami)& 3 boxes for manhattan**

**Contents of Box One.for cf1 (miami)**

- The **Fire** (Heat Engine) complete with **Glass Door**.
- The Chosen Fuel Effect, Logs, Driftwood or Pebbles (Customer Choice).
- The Remote Control Handset with Batteries
- The fire fixing kit containing screws and plugs and instructions ,and foam sealing strips

**Contents of Box One.for manhattan**

- The fire (heat engine) complete with glass door
- The Remote Control Handset with Batteries

**Contents of box 2 cf1 (miami )and manhattan**

- The wall fixing frame
- The rear decorative trim
- The front hinged door and trim

**The contents of box 3 manhattan only**

- The Chosen Fuel Effect, Logs, Driftwood or Pebbles (Customer Choice).
- The fire fixing kit containing screws, plugs and instructions ,and foam sealing strips

**Under no circumstances must the appliance be installed without fitting the wall fixing frame first and ensure it is sealed in completely on four sides either using the foam strips or preferably sand and cement to ensure a good seal into the builders opening.**

**7.Installation requirements**

In your own interest and that of safety, it is law, that all gas appliances must be installed by a competent person who is a member of a recognised gas installation organisation (e.g. Gas safe) In accordance with Current Gas Safety (**INSTALLATION AND USE**) Regulations. Before installation, ensure that the local distribution conditions (identification of the gas and pressure) and the adjustment of the appliance are compatible. The installation must be in accordance with these installation instructions and all relevant parts of the Local and National Building Regulations, the Building Standards (Scotland) Regulations and the relevant recommendations of current editions of the following British Standards: -

<b>BS</b>	<b>BS</b>	<b>BS</b>	<b>BS</b>	<b>BS</b>
5871	8303	5440 PART 1	5440 PART 2	6891

**IMPORTANT:** This appliance is fitted with a spillage monitoring system, (ODS) and must not be adjusted, bypassed or put out of operation, by the user or installer. Any parts of this system should only be exchanged for genuine crystal manufacture parts.

This fire must not be installed in a room that contains a bath or shower.

This fire cannot be installed onto a combustible wall. All combustible materials must be removed from the area shown in **Fig 11:1/11:1a**

No combustible materials must be present in the builders opening.

These Instructions must be left with the User.

Keep any Plastic Bags away from Children.

**VENTILATION :GB**

For installation in Great Britain additional ventilation is not normally required unless indicated as being required by the 'Spillage Test'

**VENTILATION : IE**

For installation in Southern Ireland ventilation must be in accordance with I.S813 Domestic Gas Installations.

8. Technical data

MODELS	Cf1 (MIAMI) & MANHATTAN
GAS TYPE	NATURAL GAS ONLY
SUPPLY PRESSURE	20 mbar
CATEGORY	I2H
INJECTOR	440
GAS CONNECTION	8mm COMPRESSION
HIGH HEAT INPUT	6.9kW (gross)
LOW HEAT INPUT	2.9kW (gross)
WEIGHT	25 KG
EFFICIENCY	CLASS 1

## 9.DIMENSIONS

GENERAL DIMENSIONS	Cf1 (MIAMI)	MANHATTAN
HEIGHT	615mm	765mm
WIDTH	1020mm	1020mm
DEPTH	375mm	375mm
DEPTH WITHIN OPENING	275mm	275mm
MINIMUM OPENING DEPTH	285mm	285mm

The only difference between the 2 appliances is the manhattan is 150 mm taller

## 10.contents of fixing kit

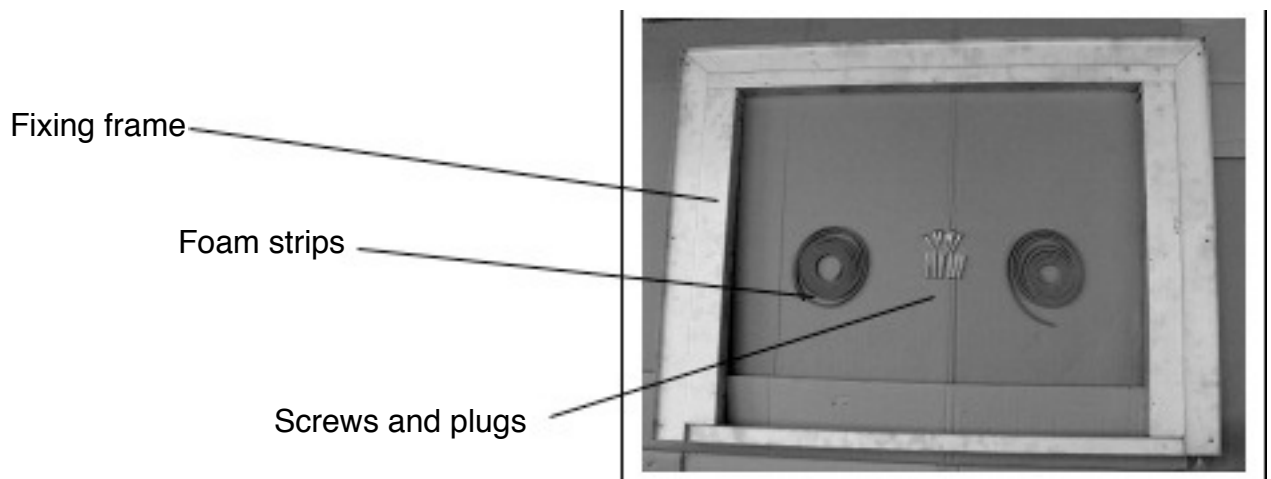

Fig 10:1

Fixing frame in box 2 fixing kit found in with fuel kit and foam strips

**Warning slight dimensional changes may occur without notice for constant improvement**

# 11.appliance location

The diagrams below shows the maximum and minimum Height and width dimensions of the Builders Opening with the grey shaded area representing the minimum flat surface area required around the fire.

Any combustible materials must be removed from this area.

Care should be taken to prevent any damage being caused to surrounding soft furnishing or decoration, many wall coverings (E.G.) Embossed vinyl may become Discoloured if placed to close to the appliance.

**WARNING: - A suitable guard should be used for he protection of children, the elderly and the infirm.**

The fire must be fitted against a non-combustible surface, which must extend 150 mm past any edge Of the appliance.

Where a suitable fire surround is not used it is Recommended that a non-combustible shelf is fitted At least 60mm above the fireplace opening.

This will help to reduce the effects of wall staining.

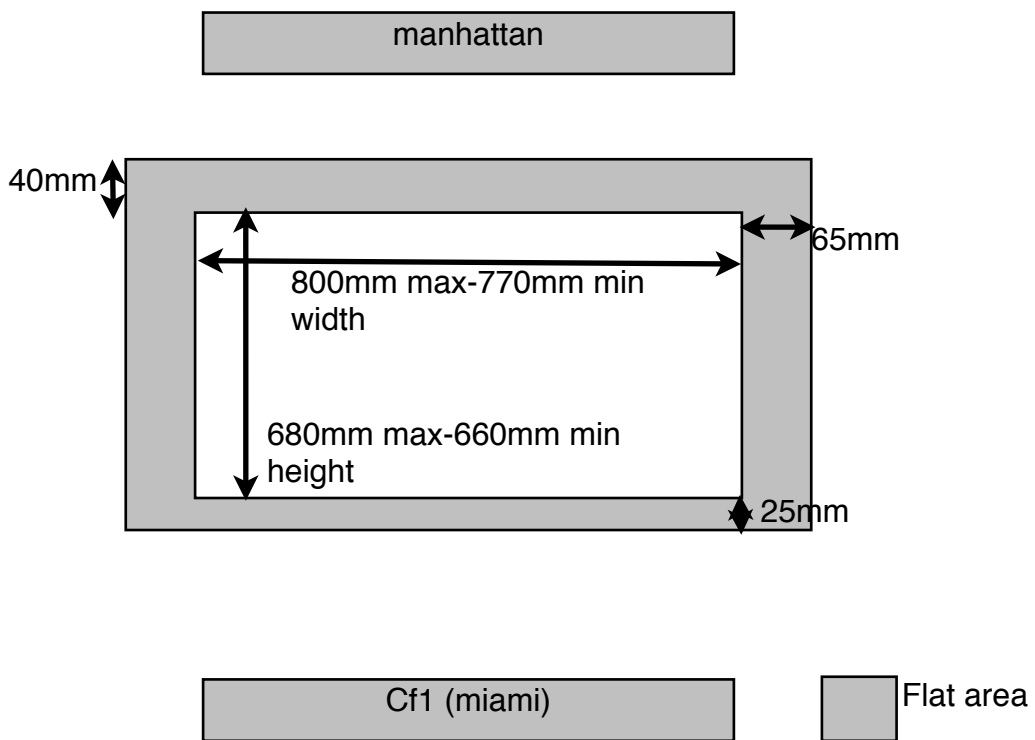

Fig 11:1  
manhattan

Fig 11:1a  
Cf1 (miami)

## 12.flue and builders opening requirements

Prior to creating the builders opening the flue must be checked.

No restrictor plate or flue damper is permitted.

The flue must be swept prior to installation.

The flue must be free of any obstructions.

The flue must be checked to ensure it **only** serves the fireplace opening to be used for the fire.

The flue must have a positive up-draught and checked as follows before the builders-opening is constructed:

Before installing the fire a simple smoke test should be carried out on the flue to check its condition. Light a smoke generator, hold it at the top of the fireplace opening and observe that the smoke is being drawn up the flue, if so, proceed with installation. If not, pre heat the

Flues for a few minutes and recheck, if smoke still fails to be drawn up the flue, further

Investigation is required and the appliance **MUST NOT BE FITTED**.

The effective height of the flue must be at least 3 metres

### A

#### **Purpose Made Builders Opening With a Conventional Stone Flue.**

With a minimum cross sectional dimension of 175mm (7") and a minimum effective height of 3 metres. **Fig 12:1a** shows the minimum and maximum sizes of the builders opening.

The base of the builders opening must be a non-combustible material and at least 12mm thick. The Builders Opening must be at least 300mm off the floor for a wall mounted fire installation.

It is recommended that a qualified builder construct the builder's enclosure.

A lintel should be used to support the chimney breast above the Builders opening.

Any gaps around the Builders Opening as may be the case With a dry liner wall must be sealed.

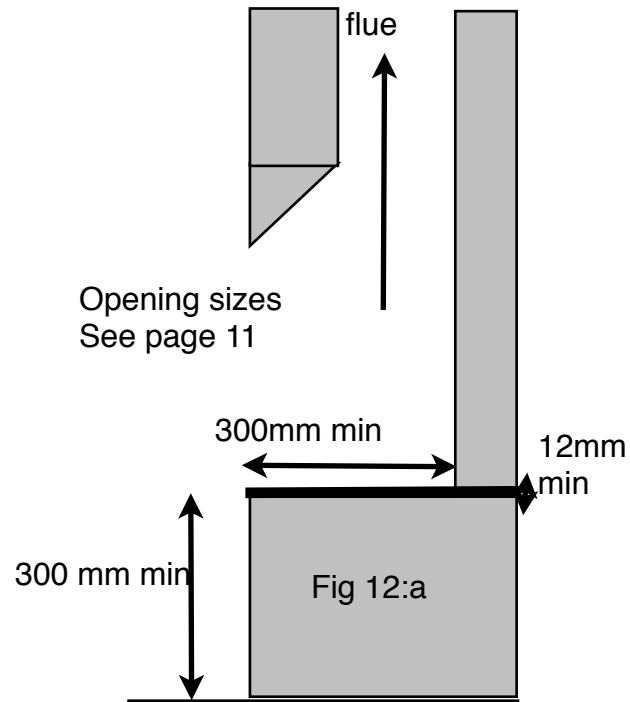

### B

#### **Additional Requirements for a Purpose Made Builders Opening below a Flexible Flue Liner.**

A 125mm (5") diameter flexible gas flue liner conforming to B.S 715, and connected to a Register Plate fitted and sealed above the Builders Opening.

See **Fig 12:1b**

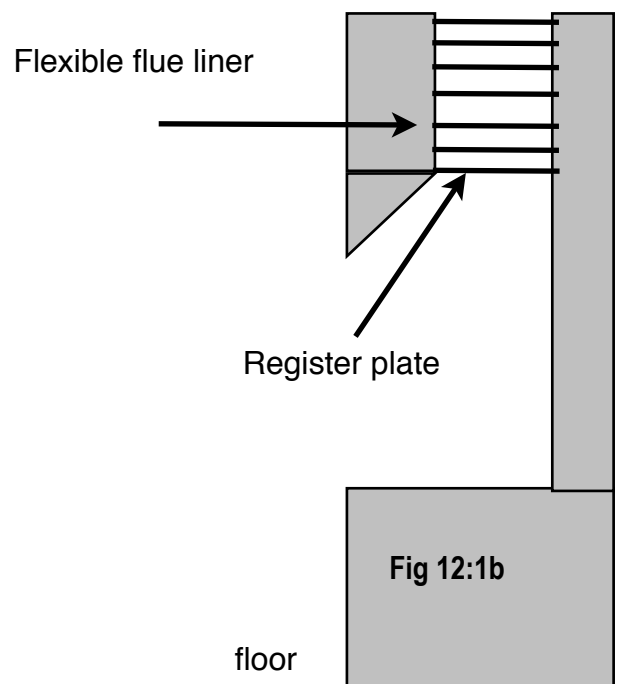

**Installation into a Suitable Fire Surround and Hearth**  
**With Combustible and Non Combustible Shelf Requirements.**

If the fire is to be installed into a suitable fire surround it must have a fire rating of 150C.

The fireplace opening must be at least 60mm above the upper surface of the hearth.

The Hearth must be non-combustible and protrude at least 300mm in front of the fire and be at least 1000mm wide.

The upper surface of the hearth must be at least 12mm thick and it should be raised off the floor by 50mm to protect against the possibility of carpets sliding on to the hearth. If the hearth as an up-stand the base of the fireplace opening will have to be raised the height of the up-stand to ensure the outer door can still be opened.

See **Fig 11:1 & Fig 11:1a** for the minimum flat areas required for the fire surround backboard.

If the fire surrounds as a combustible shelf it must be at least 200mm above the top of the builders opening

And protrude from the wall be no more than 150mm

See **Fig 13:1**.

For every 25mm increase in depth of combustible

Shelf the position of the shelf must be raised by a further 25mm.

If the shelf is a non-combustible shelf it must be fitted at least 60mm above the builders opening and its depth is not restricted.

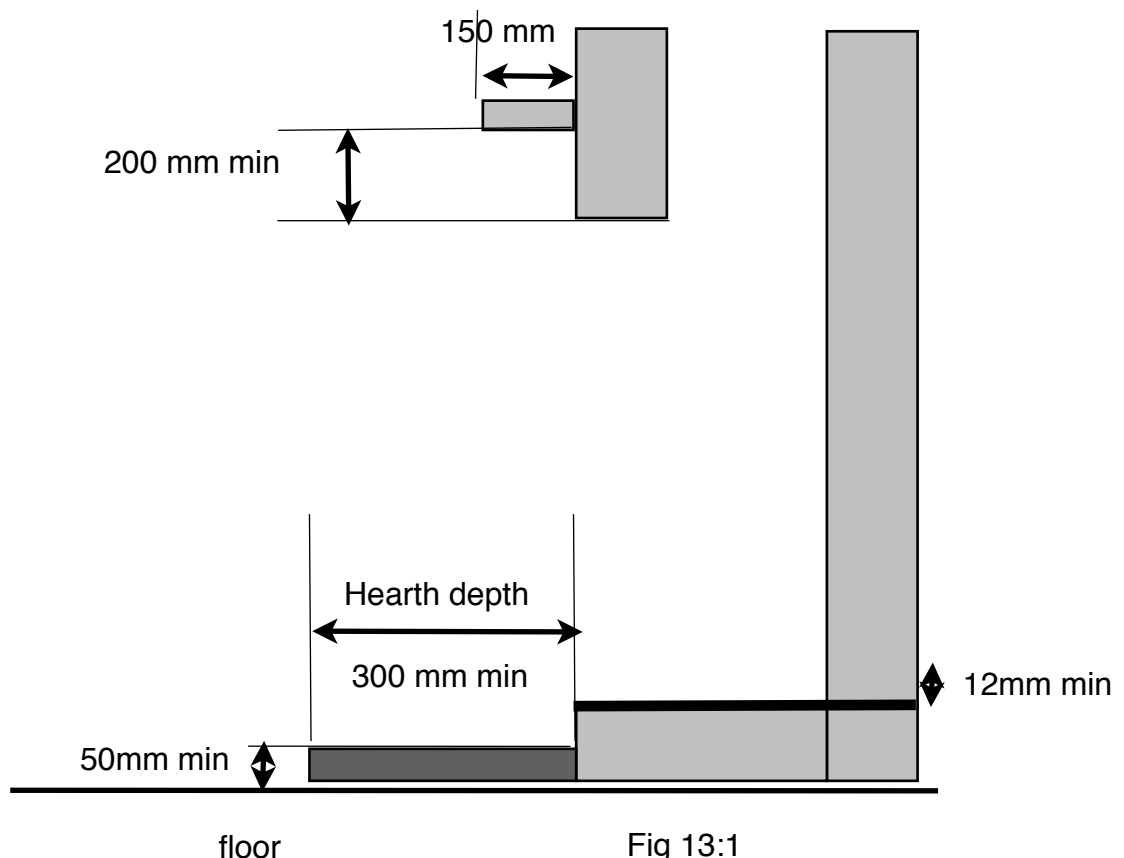

## 14 ventilation

No purpose provided additional ventilation is normally required, however this is subject to the spillage test

In the Republic of Ireland (IE) ventilation shall be in accordance with **I.S813 Domestic Gas Standards**.

Any purpose provided ventilation should be checked regularly to ensure that this is free from obstruction.

### **IMPORTANT**

This appliance is fitted with a spillage monitoring pilot system (ODS) and must not be adjusted, by-passed or put out of operation by the user or installer. Any parts of this ODS pilot system must only be exchanged for genuine crystal parts.

## 15.gas supply

Ensure the gas supply is correct and is Natural Gas  
With a minimum supply pressure of 20mbar.

The gas installation must be in accordance with the latest issue of BS6891.

Route the gas supply into the rear of the builders opening to the left as you are looking at the appliance

Care should be taken to sleeve the supply pipe when fitting through masonry.

Only use a rigid or semi-rigid metal tubing of 8mm can be used.

A combined Restrictor Elbow with Pressure Test Point is supplied with the fire and comes complete with a 8mm nut and olive see **Fig 15:1**.

All gas pipes must now be purged of both air and any debris that may have entered the pipe work.

With the Restrictor Elbow fitted and sealed off pressure test all pipe work before proceeding with installing the fire.

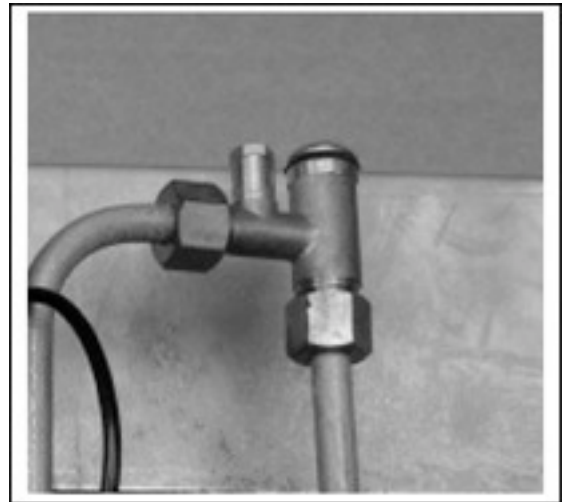

**Fig 15:1.**

## 16.installing the fire

Remove the **Fixing Frame** from the box and fit the foam seal provided as shown in **Fig 16:1**.

The Frame can be fitted to the builders opening using the screws and Raul plugs provided by either fixing it at the front or fixing inside the builders opening.

If a fire surround is to be used then it is recommended that the fixing should be inside the builders opening so as to not risk damaging the fire surround.

Important: Ensure the foam seal is clamped up against the wall to ensure it seals the opening.

If any gaps are present they must be sealed with either fire cement or ideally a high temperature silicone sealant.

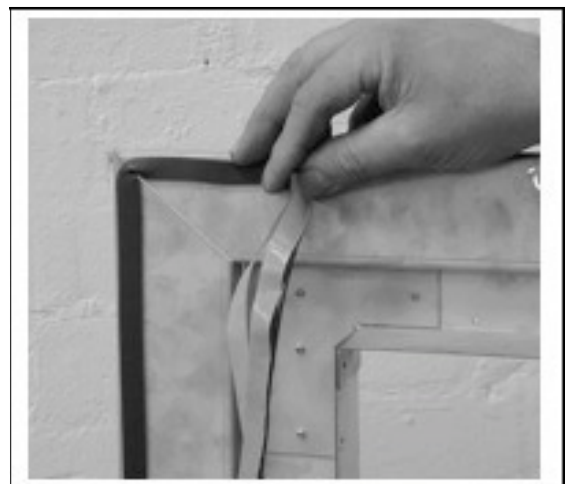

**Fig 16:1**

If the wall is perfectly flat it is recommended the outer frame is fitted and sealed from the inside with high temperature silicone ,fire cement or sand and cement

**The outer frame must be sealed so no air can pull through it after installation all the flue pull must be made through the fire diverter and from no other place ,**

The foam seal provided must now be fitted to the **Outer Frame** of the fire as shown in **Fig 16:2**. The fire can now be carefully fitted by guiding the gas supply complete with Restrictor Elbow through the gas entry hole in the rear of the fire.



Fig 16:2

The fire should now be sealed to the sealing frame using the screws provided. Fit the Outer Trim (Black) to cover the sealing frame. It will be necessary open the Glass Door to enable you to tilt the Outer Trim to guide it around the Glass Door then fix with the screws provided. See **Fig's 16:3a & Fig 16:b**.



Fig 16:3a

Make the final gas connection by sealing the Restrictor Elbow to the Control. Unseal the Restrictor Elbow and check the gas joint for gas soundness.

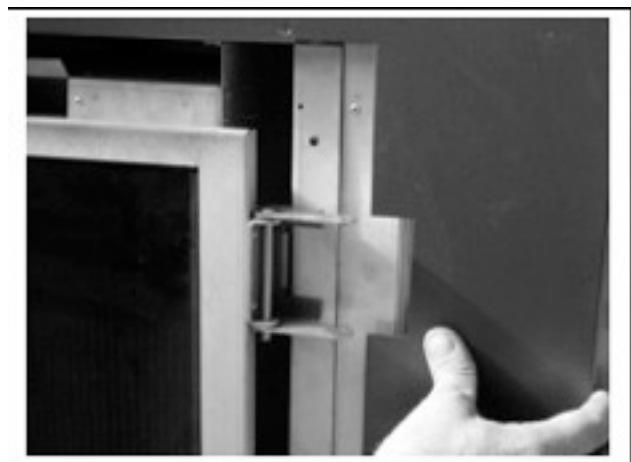

Fig 16:3b

## 17. Commissioning the appliance

Remove the customers chosen fuel effect pieces from the pack and check that none are broken or damaged.

If Logs or Driftwood has been chosen it will be necessary to leave the **Log Support** fitted with the 3 Screws see **Fig 17:1**.if pebbles have been chosen it will need removing

Making reference to the photographs in **Sections 18 for Logs or Driftwood and Section 19 for Pebbles in the Installation Instructions** fit the Fuel

Fig 17:1

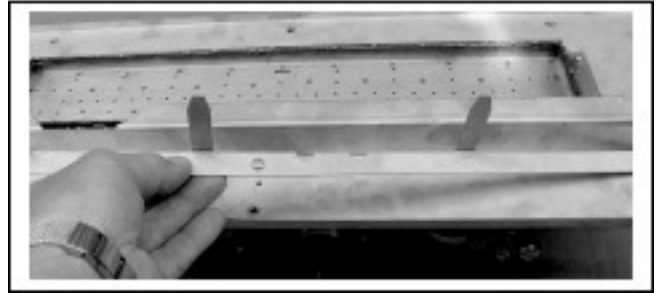

### **Important**

**Ensure the Burner Ceramic Base Pad is fitted the Right way around with the central slot at the rear**

**Normally factory fitted**

**Ensure no granules are placed on top of the Burner Ceramic Base Pad.**

**Only place Bark Chips in the areas shown.**

**Ensure the Pilot is visible and not covered especially when fitting Pebbles onto the Ceramic Base Pad.**

Seal closed the **Glass Door** after checking that the glass is clean using the screws to secure it

Fit the **Outer Door** using the **Hinge Pins** provided. See **Fig 17:2**.



Fig 17:2

With making reference to 2:1 light the pilot turn on the appliance and check the gas pressure of the appliance is 20 mbar on full

## 18.fuel logs and driftwood layout

### **Open the Outer Door and undo the 2 Left Hand Screws Retaining the Glass Door**

### **Fitting the Fuel Effect Components**

**IMPORTANT:-** It is important that the chosen fuel bed components are laid out exactly as in these instructions any variations may lead to incorrect or possible hazardous operation.

The Fire can be ordered with the following fuel effects:

**Fuel Effect Logs.**

**Fuel Effect Driftwood.**

**Fuel Effect Pebbles.**

Reference should be made to the relative Fuel Effect Layout Sections in these Instructions, please read thoroughly before proceeding.

When placing Logs or Driftwood Pieces over the burner ensure that they are sitting on the metal peg locations provided at the front of the fire.

### **REQUIRED FOR BOTH LOGS, DRIFTWOOD & PEBBLES**

### **Important required for all Fuel Effects**

Position the **Burner Ceramic Base Pad** (normally factory fitted )

**Important the Central Flame slot must be to the back**

**Although with the new burner design no flames come from the rear of the burner it is correct to keep the central rear slot at the back to ensure good cross lighting**

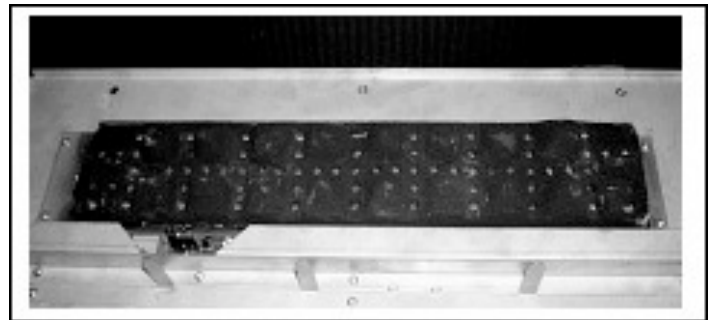

Fig 18:0

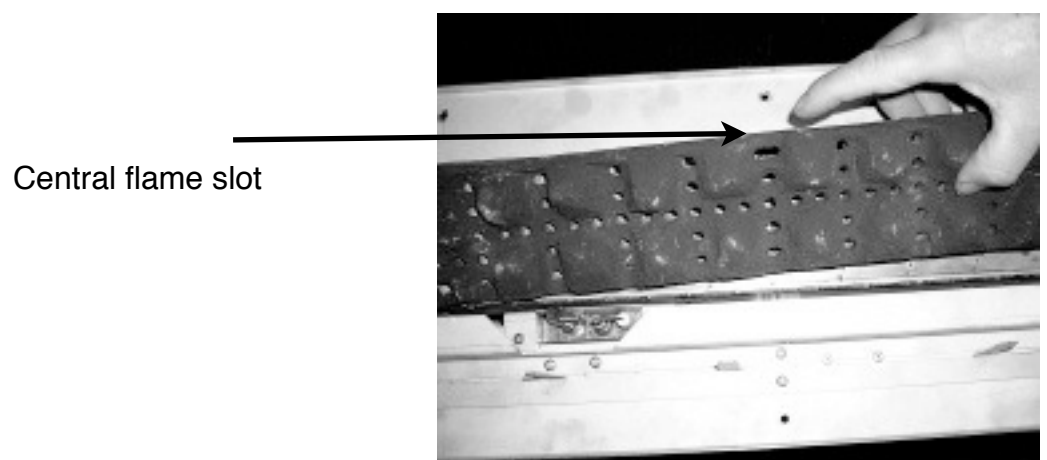

Fig 18:1

## Logs and driftwood layout

### Fitting Logs or Driftwood Pieces

Note all the Log or Driftwood pieces

Have numbers on their Base

Fit the **Large Rear Log or Driftwood Piece No1**  
Behind the burner as shown in **Fig.18: 2**

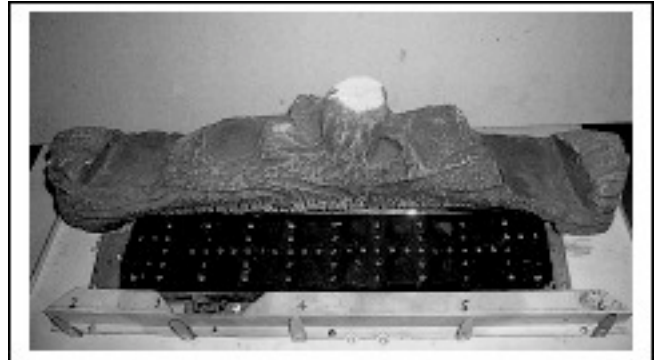

Fig 18:2

### 20:3

#### Fitting the granules

**Important the granules must not**  
Be placed onto the **Burner** or any part of  
The **Ceramic Base Pad**.

Ensure **no granules** fall onto the **Pilot**  
Carefully place the **granules** around  
the front of the **Metal Air Guide** and around  
the sides of the rear log. As shown in **Fig 18:3**  
**Do not block air inlets on fire tray**



Fig 18:3

### 20:4

#### Fitting Log or Driftwood No2

Fit **Log or Driftwood No2** at the left hand  
Side ensuring the hole in the base locates  
On to the metal peg at the front and it rests  
In the groove in the **Rear Log/Driftwood**  
As shown. **Fig 18:4**

**AT THIS POINT PLACE 1 OR 2**  
**BARK CHIP OVER THE CENTRAL FLAME SLOT AS**  
**SHOWN**

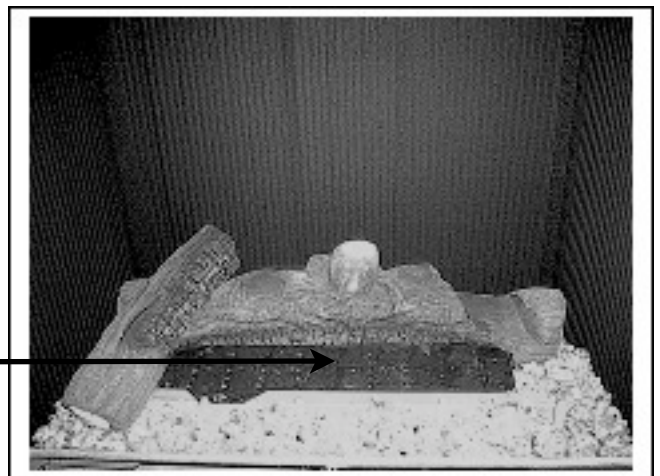

Fig 18:4

**20:5**

**Fitting Log or Driftwood No3**

Fit **Log or Driftwood No3** next to the last Piece ensuring the hole in the base locates Onto the metal peg at the front and it rests On the **Large Rear Log/Driftwood** as shown. **Fig 18:5.**



Fig 18:5

**20:6**

**Fitting 'V' Log or Driftwood No4**

Fit **'V' Shaped Log or Driftwood No4** Next to the last piece ensuring the hole In the base locates onto the metal peg At the front and it rests around the **Branch** on the **Large Rear Log/Driftwood** As shown **Fig. 18:6**



Fig 18:6

**18:7**

**Fitting Log or Driftwood No5**

Fit **Log or Driftwood No5** next to the last Piece ensuring the hole in the base locates Onto the metal peg at the front and it rests On the **Large Rear Log/Driftwood** as shown in



Fig 18:7

**20:8 Fitting Log or Driftwood No6**

Fit the last **Log or Driftwood No6** at the far Right Hand side ensuring the hole in the base locates Onto the metal peg at the front and it rests In the groove in the rear **Large Rear Log/ Driftwood** as shown. Adjust the **granules** between The **Log/Driftwood** to hide any metalwork that may Be showing see **Fig. 18:8**



Fig 18:8

### Fitting the Bark Chips

Carefully place some of each colour of the **Bark Chips** on top of the **Vermiculite Chips**.

Finally strategically place one or two pieces of each colour of **Bark Chips** onto the **Burner Ceramic Base Pad** between the Logs where they will be seen as shown in **Fig 18:9**

**Important** do not place any pieces Directly in front of the **Pilot**.

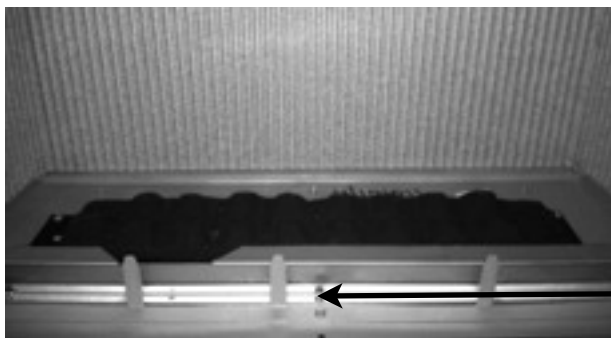

Fig 18:9

Finally ensuring the **Pilot** is visible and clear of any **Vermiculite and/or Bark Chips**.

Check that the **Glass Door** is clean then seal closed with the 2 screws

## 19. PEBBLE SET



The log support bracket must be removed before the pebbles can be installed by removing 3 self tapping screws and lifting away the bracket

Keep bracket and screws safe if for any reason you may wish to return to the log set up in the future

The fibre base is factory installed , however the rear fibre strip has to be positioned as right .

Ensure it is pushed up to lip of tray (**ensure it does not cover the aeration hole behind the fibre base shown** )

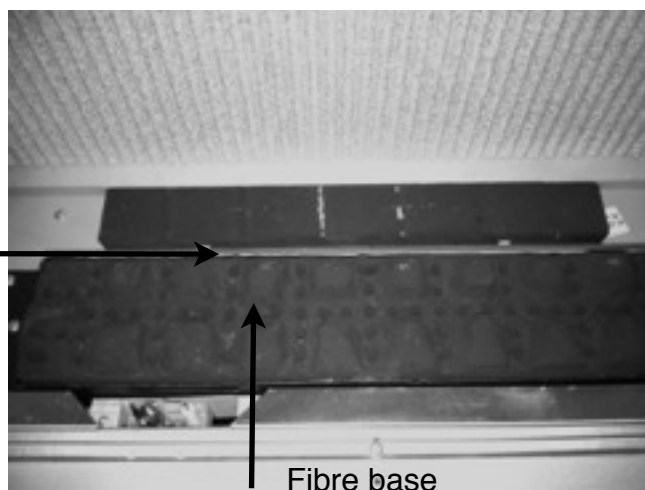

Fibre base



The granules can then be spread around the fire tray and behind the fibre strip packing it to ensure the strip cannot move

Level the granules so the metalwork is covered

**Important the aeration hole behind fibre base and in front of fibre strip must not be blocked with the granules**

**Recheck to ensure the aeration holes clear**

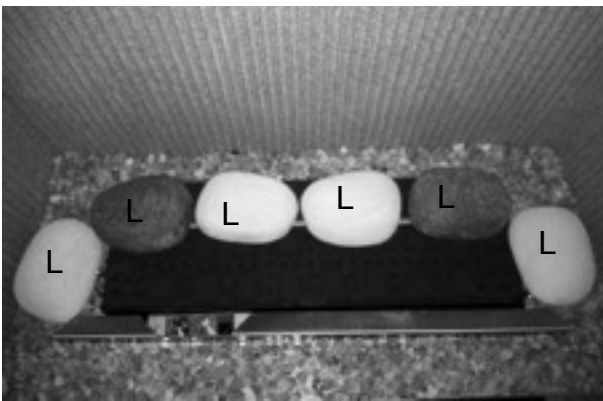

L pebbles  
(marked L underneath)

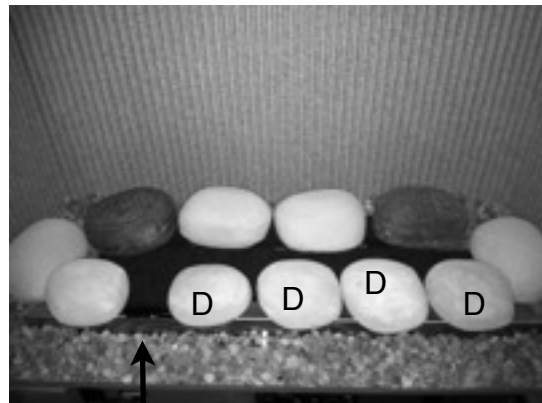

D pebbles  
(marked D underneath)

Gap for pilot light

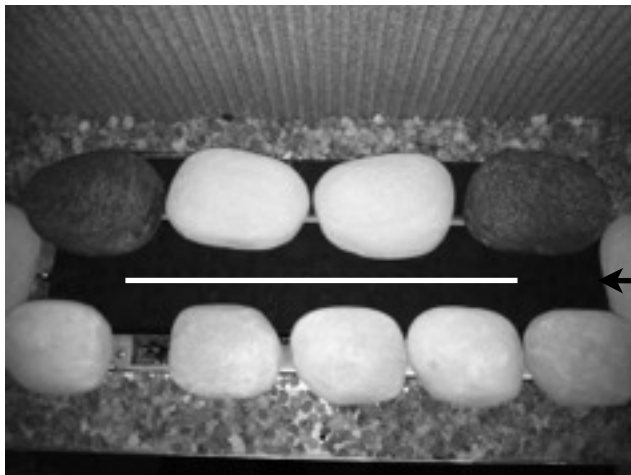

White strip shows central burner ,this must be kept clear

The four pebbles marked L sit at the rear of the base pad and on to the fibre strip as left above  
The final 2 pebbles sit at the side as above .  
The 5 pebbles marked D sit on the brushed silver bracket and on to the fibre base as above centre ensuring there is a gap above the pilot light  
Final picture to the right shows the gap between the pebbles ,under no circumstances must the flames burn over the pebbles ,however they will slightly touch the rear pebbles and will make them glow slightly

## 20. Lighting the fire

Following the instructions on page 4 and turn on the appliance ,check the operation of the handset turning the fire up and down ,  
Leave fire in the full position and carry out spillage test

## 21. Test for spillage

Close all doors and windows.

Open the Outer Door of the Fire and with the fire operating at High after 5minutes apply a smoke match at the Diverter Inlet as shown in **Fig 21:1**. All smoke should be drawn into the Diverter, if not wait a further 10minutes and repeat the test.

If there are any Extraction Fans in the room or Adjoining rooms set them at maximum and with the Door to this room open repeat the above test.  
If spillage still occurs Seek Expert Advise.

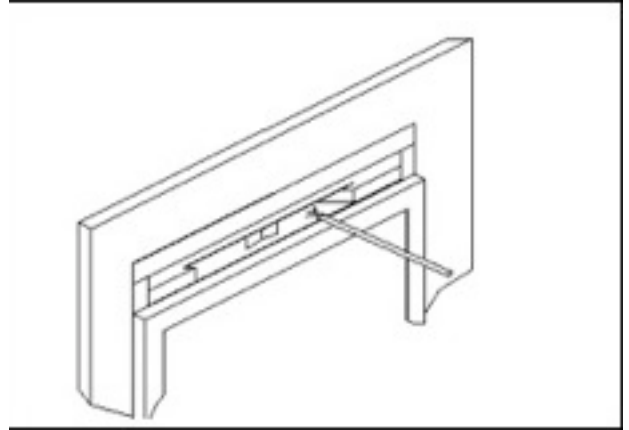

Fig 21:1

If spillage persists it could be either a Flue problem requiring checking of the condition of the Flue or a lack of Ventilation. To check for a lack of Ventilation Air open a window slightly in the room or adjoining room, then again check for spillage. If this corrects the problem then additional ventilation (Air Brick) will be required.  
Seek expert assistance with all these issues, as the customer will need to be advised.

## 22.instruct the user

### 22:1

Instruct the user on the safe operation of the appliance.

Demonstrate how to operate the Remote Control System.

Explain the function of the ODS as described earlier.

Any cleaning procedures should only be undertaken with the appliance cold.

Show the Customer how to gain access to the Glass Door for cleaning on the Outside and how to gain access to the Inside for cleaning.

Advise the customer that the fire must **never** be used with the Door Open or if the Glass Panel is found to be cracked chipped or damaged.

Draw the customer's attention to the Section in the Users on Wall Staining and the position of Combustible wall coverings.

Hand all the Instructions to the user for safekeeping and future reference.

Advise the Customer that the Batteries in the Remote Control Hand Set and Receiver must be replaced at the beginning of the next Heating Season

Advise the customer that the flue and fire should be Serviced Annually for continued safe operation

23:1

**General Checks prior to any Servicing or Maintenance.**

The fire must be serviced every year by a competent person in line with current CORGI recommendations.

It is recommended that a gas soundness test be conducted before any Servicing.

It is also recommended that the operation of the fire be checked prior to any Servicing.

After these checks and before any Servicing is carried out, make sure the Fire is COLD.

**General Servicing.**

Lay a dust sheet in front of the Fire.

Open the Outer Door and Isolate the fire from the Main Gas Supply by sealing it off at the Isolation Elbow provided.

Check any of the Fuel Effect Pieces for Soot build up, clean and refit.

Check for any Lint build up around the pilot, ensuring there is no lint at the Aeration Hole of the Pilot.

Check for any Lint build up around the Burner Aeration Hole at the Left Hand End of the Burner.

Check if the fire was installed with a Flue Liner or into a Conventional Unlined Chimney.

If **Not** lined then using a torch look through the hole around the gas inlet pipe and check for any appreciable build up of Debris. If there is a build up of Debris the Fire will have to be removed

Before resealing the Glass Door and Re-commissioning the fire ensure the Glass Panel is Clean.

Reconnect the gas supply.

Check all faults have been corrected then re-commission the fire, conducting the usual safety checks and **specifically gas soundness and spillage tests.**

Fit new batteries into the Handset and Receiver

Finally with the Outer Door Closed ensure the Remote Control Handset operates the fire correctly

**Removing the Burner Mounting Plate Assembly.**

All gas components can be serviced or replaced without removing the fire, however the Burner Mounting Plate Assembly will have to be removed requiring the Fuel Effect Components (e.g. Logs, Driftwood or Pebbles) to also be removed.

Lay a dust sheet in front of the Fire.

Open the Outer Door and Isolate the fire from the Main Gas Supply by sealing it off at the Isolation Elbow provided.

Open the Glass Door by removing the 2 Screws at the Left Hand Side

Carefully remove the Fuel Effect Pieces as follows:

**For Logs or Driftwood.**

For Logs or Driftwood remove the Bark Chips and segregate into 2 colours.

Remove the Logs or Driftwood by lifting the Top Pieces first off the front locating pegs then the Large Rear Log.

Collect and Remove the granules

Remove the Log/Driftwood Support to prevent it becoming damaged

Lift the Burner Matrix Pad out of the Burner

**Or**

**For Pebbles**

For Pebbles remove and separate into the 3 different sizes.

Collect and Remove the Vermiculite Chips.

Lift the Burner Matrix Pad out of the Burner.

**Note: Have you isolated the gas supply?**

Disconnect the gas-tubing nut to the side of the Isolation Elbow and move the pipe clear of the Control.

**Disconnect the Receiver:** disconnect the receiver by removing the electrical connectors from the upper Left Hand corner of the Main Control.

remove and retain  
The 6 screws securing the Burner Mounting  
Plate Assembly.

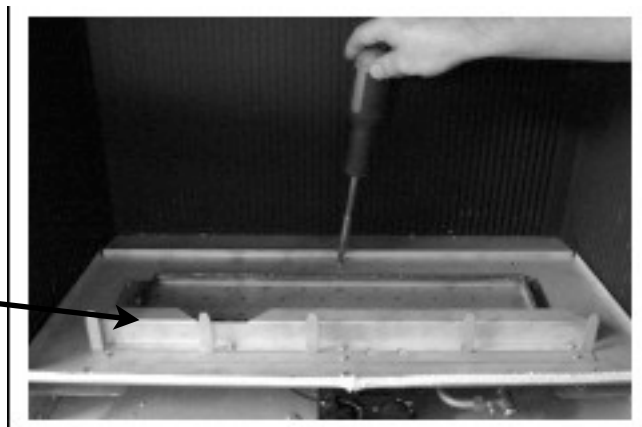

Whilst lifting the Assembly at the rear, rotate it towards you and remove it from the Fire taking care not to foul the Side Liners of the fire.

All gas carrying parts are now accessible for servicing or replacement.

For refitting follow the above Instructions in reverse order.

**Ensure you replace the fuel pieces following the relevant instructions**

**23:2**

**Removing the Fire.**

*Note: This should only be required for removal of Debris or to check the condition of the Flue/Chimney.*

The fire is installed into a special Wall Sealing Frame so that the wall fixing/cladding will not need to be disturbed when the fire is removed.

Lay a dust sheet in front of the Fire.

Open the Outer Door and Isolate the fire from the Main Gas Supply by sealing it off at the Isolation Elbow provided.

Remove the **Outer Door** by removing the **Hinge Pins** on the Right Hand side see **Page 16 Fig 17:2**

Open the **Glass Door** by removing the 2 Socket Screws at the Left Hand Side

Carefully remove the fuel effect pieces as follows:

**For Logs or Driftwood.**

For Logs or Driftwood remove the Bark Chips and segregate into 2 colours.

Remove the Logs or Driftwood by lifting the Top Pieces first off the front locating pegs then the Large Rear Log.

Collect and Remove the granules.

Remove the Log/Driftwood Support to prevent it becoming damaged

Lift the Burner Matrix Pad out of the Burner.

Or

### **For Pebbles**

For Pebbles remove and separate into the 2 different sizes.

Collect and Remove the granules.

Lift the Burner Matrix Pad out of the Burner.

### **Note: Have you isolated the gas supply?**

Disconnect the gas-tubing nut to the side of the Isolation Elbow and move the pipe clear of the Control.

Remove the screws securing the **Outer Trim** to the **Fixing Frame** See **Fig's 16:3a & Fig 16:3b. On Page 15**, it will be necessary to open the **Glass Door** to enable you to manoeuvre **Outer Trim** over the **Glass Door**.

Secure the **Glass Door** with the 2 securing screws to prevent it swinging open.

Remove the screws securing the **Fire** to the **Wall Sealing Frame**.

**The Fire can then be slid clear of the Wall Sealing Frame taking care to ensure the Gas Inlet Pipe complete with Isolation Elbow clears through the slotted cut out at the rear.**

Remove any Debris from the rear of the fire.

Replace the fire by following the above instructions in reverse order.

Check that the foam seal is adequately sealing the fire to the fireplace opening.

For refitting the Fuel Bed components see **relevant sections**

Check all faults have been corrected then re-commission the fire, conducting the usual safety checks and specifically gas soundness and spillage tests.

Fit new batteries into the Handset and Receiver

Finally with the **Outer Door** Refitted and Closed ensure the Remote Control Handset operates the fire correctly.

23:3

### **Changing the ODS Pilot Assembly.**

**The ODS Pilot Assembly is not a Serviceable item and for continued Safety MUST only be replaced with a genuine crystal Fire Ltd Part.**

#### **Follow Section 23:1 Removing the Burner Mounting Plate Assembly.**

If Logs or Driftwood is being used remove and retain the 3 screws securing the Log Support to prevent it becoming damaged

Remove and retain the 3 screws securing the Air Guide.

With the Burner Mounting Plate Assembly Upside down, disconnect the Electrode Lead from the Pilot Electrode, and disconnect the Pilot Pipe from the base of the Pilot

Assembly and the Thermocouple from the Main Gas Control

Remove and exchange the ODS Pilot by removing and retaining the 2 securing screws.

Replace the parts in reverse order.

For refitting the Fuel Bed components see **relevant section**

Check all faults have been corrected then re-commission the fire, conducting the usual safety checks and specifically gas soundness and spillage tests.

Fit new batteries into the Handset and Receiver

Finally with the Outer Door Closed ensure the Remote Control Handset operates the fire correctly

### **Changing the injector**

Follow instructions above to remove fuel and remove 4 screws holding on the aeration bracket

Disconnect the nut on pipe to injector and remove injector and aeration bracket

Change injector and replace in reverse order

**23:4**

**Changing the Gas Control.**

**Follow Section 23:1 Removing the Burner Mounting Plate Assembly.**

If Logs or Driftwood is being used remove and retain the 3 screws securing the Log Support to prevent it becoming damaged

Remove and retain the 3 screws securing the Air Guide.

With the Burner Mounting Plate Assembly upside down disconnect the Electrode Lead from the Pilot Electrode, disconnect the Pilot Pipe from the back of the Main Control and the Thermocouple from the Main Gas Control.

Disconnect the Outlet/Injector Pipe and the Main Inlet Pipe.

Remove and retain the 2 screws securing the Main Control.

Fit the new Control and replace all parts in reverse order.

For refitting the Fuel Bed components see relevant section

Check all faults have been corrected then re-commission the fire, conducting the usual safety checks and specifically gas soundness and spillage tests.

Fit new batteries into the Handset and Receiver

Finally with the Outer Door Closed ensure the Remote Control Handset operates the fire correctly.

part	Cf1/miami part no	Manhattan part no
<b>DOOR GLASS ASSEMBLY</b>	cf1	Man 1
Gas control	cf2	Man 2
handset	cf3	Man 3
receiver	cf4	man4
log set	cf5	man5
Driftwood set	cf6	man6
pebbles	cf7	man7
granules	cf8	man8
Bark chipping	cf9	man9
Ods pilot assembly seagas	cf10	man10
Injector 440	cf11	man11